

SPD

Surge Protective Device

SD10KxxxD303(H100) Serie

Description



Surge Protection Device (SPD) is a transient surge suppression device consisting of varistor (MOV), Gas Discharge Tube (GDT) and thermal fuse (ATCO). When a high-amplitude transient surge occurs in the circuit, SPD suddenly changes to low impedance, clamping the voltage to a safe level and discharging the surge current.

SETsafe | SETfuse SD10KxxxD303(H100) series is specially designed for outdoor lighting. Surge level complies with IEEE C62.41.2 Location category C high exposure level requirements to protect LED lights from damage by surges. SD05K series built-in Thermal protection, which can safely fail when suffering sustained overvoltage or internal varistor degradation.

Features

- Sealed Enclosure, IP66
- Differential and Common Mode Protections
- One-port or Two-port Surge Protective Device (SPD)
- Thermal Protection and Failure Indication

Dimensions (mm)

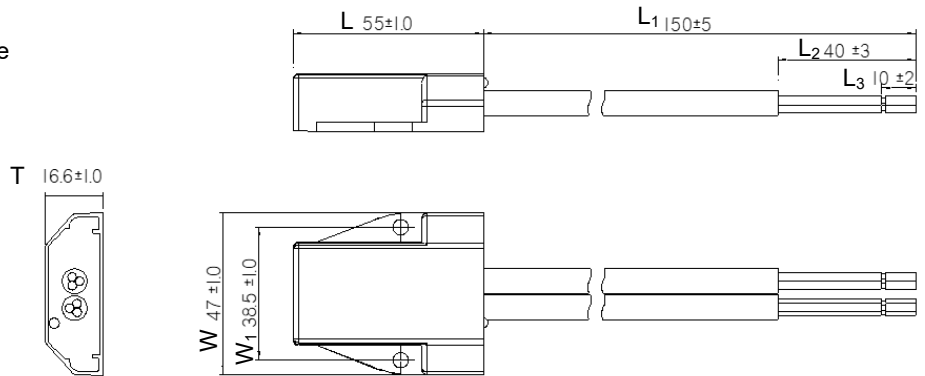

Applications



- Outdoor Street Lighting
- Parking Lighting
- Highway Lighting
- Landscape Lighting
- Traffic and Signal Lighting

L	L ₁	L ₂	L ₃
55.0 ± 1.0	150.0 ± 5.0	40.0 ± 3.0	10.0 ± 2.0
T	W	W ₁	
16.6 ± 1.0	47.0 ± 1.0	38.5 ± 1.0	

Note:

The wire length "L₁" can be customized as required.

Agency Approvals

Agency Information		Standards	NO.	Category
	TUV	IEC/EN 61643-11	50624284	Class II and Class III
	CE	IEC/EN 61643-11	50624285	Class II and Class III
	CE	IEC/EN 61643-11	HU-004878	Class II and Class III
Environment	NA	RoHS 2.0 & REACH	Compliant	

Specifications

Model	System Voltage	Max. Continuous Operat-	Nominal Discharge Current (8/20 μs)	Max. Discharge Current (8/20 μs)	Load Current	Open Circuit Voltage	Voltage Protection Level	Load Current	Agency Approvals		
	U_n	U_c	I_n	I_{max}	I_L	U_{oc}	U_p		TUV	CE	CB
	(VAC)	(VAC)	(kA)	(kA)	(A)	(kV)	(V)	(A)			
SD10K230H100	230	320	10	20	NA	20	L-N: 1500	C 16	●	●	●
SD10K277H100	277	320	10	20	NA	20	L-N: 1500	C 16	●	●	●
SD10K230H100-T	230	320	10	20	12	20	L-N: 1500	C 16	●	●	●
SD10K277H100-T	277	320	10	20	12	20	L-N: 1500	C 16	●	●	●
SD10K230D303	230	320	10	20	NA	20	L-N: 1500 L/N-PE:1500	C 16	●	●	●
SD10K277D303	277	320	10	20	NA	20	L-N: 1500 L/N-PE:1500	C 16	●	●	●
SD10K230D303-T	230	320	10	20	8	20	L-N: 1500 L/N-PE:1500	C 16	●	●	●
SD10K277D303-T	277	320	10	20	8	20	L-N: 1500 L/N-PE:1500	C 16	●	●	●
SD15K230H100	230	320	15	30	NA	30	L-N: 1500	C 16	●	●	●
SD15K277H100	277	320	15	30	NA	30	L-N: 1500	C 16	●	●	●
SD15K230H100-T	230	320	15	30	12	30	L-N: 1500	C 16	●	●	●
SD15K277H100-T	277	320	15	30	12	30	L-N: 1500	C 16	●	●	●

Note:

a: Recommended External Circuit Breaker Model C 16 A, Curve C.

"●" indicates that the product has been certified, and "○" indicates that the product has not been certified.

Packaging Information

Item	Tray	Carton
Dimensions (mm)	470 × 350 × 57	500 × 370 × 335
Quantity (PCS)	18	90

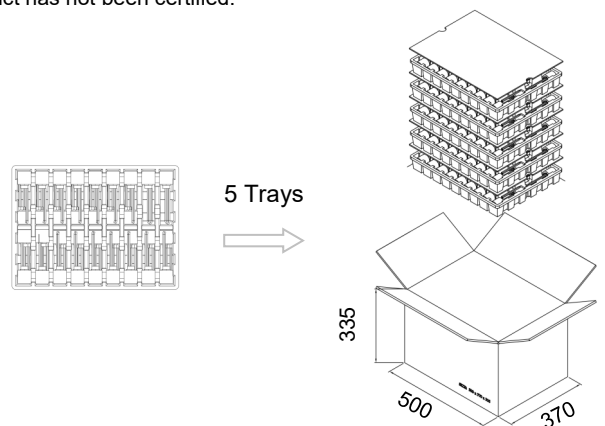

- Unit: mm
- Please contact us if you have special packaging requirement.

SPD

Surge Protective Device

SD10KxxxD303(H100) Serie

Wiring Diagram

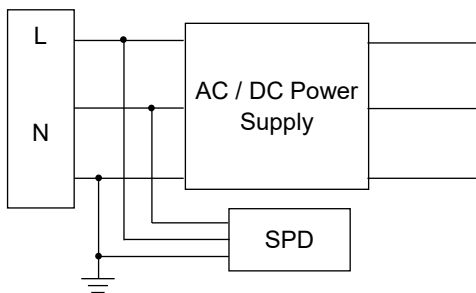

Parallel Connection (One-port)

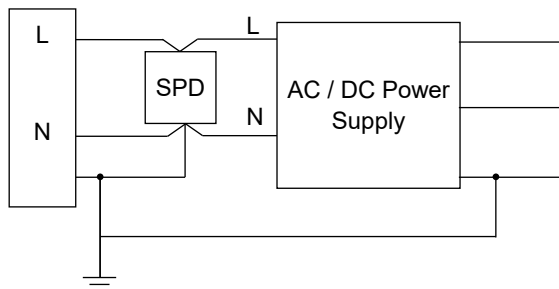

"Kelvin" Connection (Two-port)

Notes:

- Internal thermal protection.
- Two-port "Kelvin" connection SPD can reduce the effect of inductance and achieve optimum overvoltage protection.

Schematics

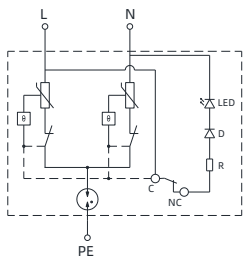

SD10KxxxD303

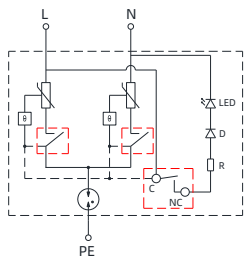

SD10KxxxD303-T

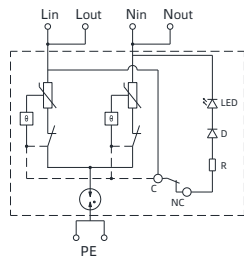

SD10KxxxH100

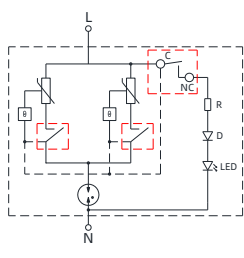

SD10KxxxH100-T

Note :

- 1、正常状态指示灯显示“绿色”，失效时LED熄灭。

Part Numbering System

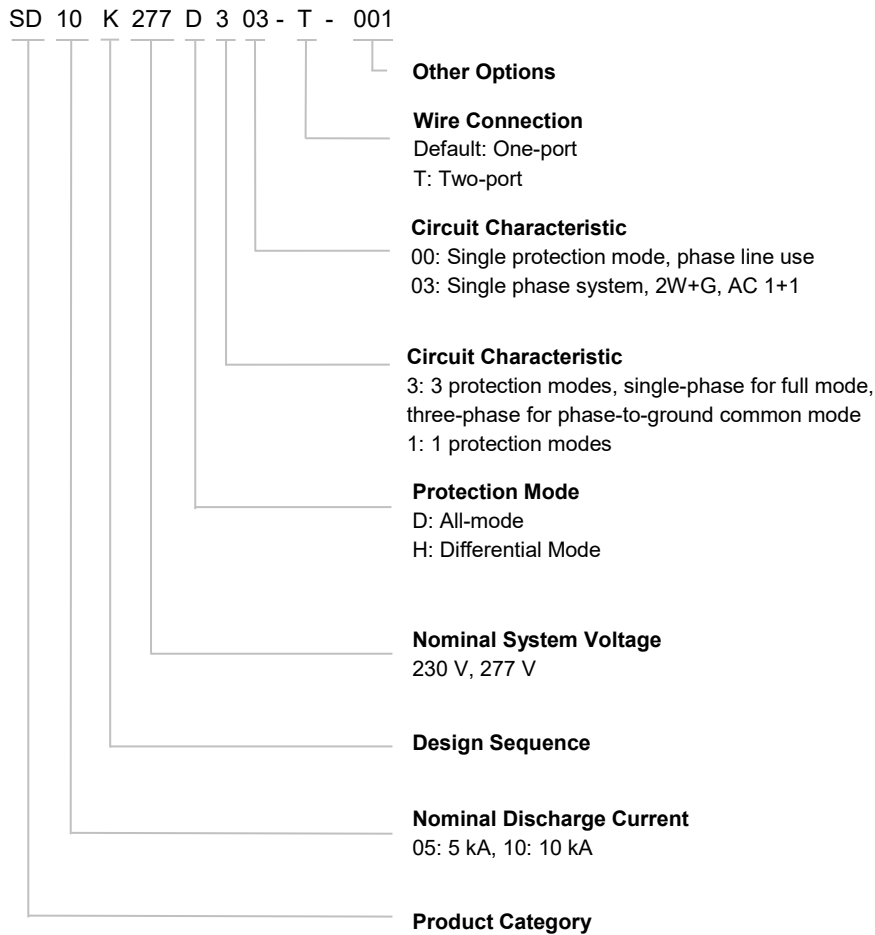

Reminder:

Part numbering system in the datasheet is only for selecting correct parameter and product features. Before placing order, please contact us for specifications and use the part number and product code in the specifications to place order to ensure the part is correct. Product code is the unique identification.

SPD

Surge Protective Device

SD10KxxxD303(H100) Serie

Overvoltage

Electricity is an essential part of modern human production and life. But power facilities are threatened by internal and external overvoltages. Power system overvoltage mainly includes:

Transient overvoltage of atmospheric origin: Lightning strikes instantly generate high energy, generating surge currents up to hundreds of kA, and lightning wave can invade along power lines, causing damage to power facilities and electrical equipment

Transient overvoltage due to switching: Switching operations of a power utility may cause overvoltage.

Temporary overvoltage: A long duration (second level) temporary overvoltage (asymmetric ground fault) or harmonious overvoltage.

Surge Voltage Caused by Lightning

Electrical and electronic system are subject to damage from a lightning electromagnetic impulse (LEMP). Therefore SPM need to be provided avoid failure of internal system. LEMP may caused by direct, near and far lightning strikes. According to the relevant research, lightning strikes within a certain distance may cause dangerous overvoltage on the cable, endangering the equipment connected to it.

Damage Due to Lighting

The lighting can cause three basic type of damage:

- D1: injury to living beings by electric shock;
- D2: physical damage (fire, explosion, mechanical destruction, chemical release) due to lighting current effects, including sparking;
- D3: failure of internal systems due to LEMP

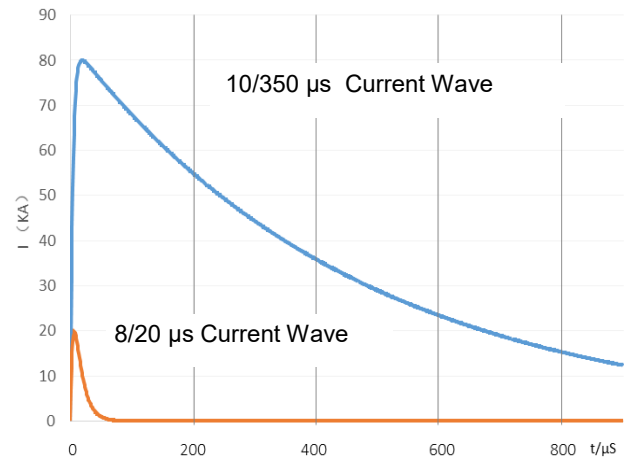

Standard lightning test wave

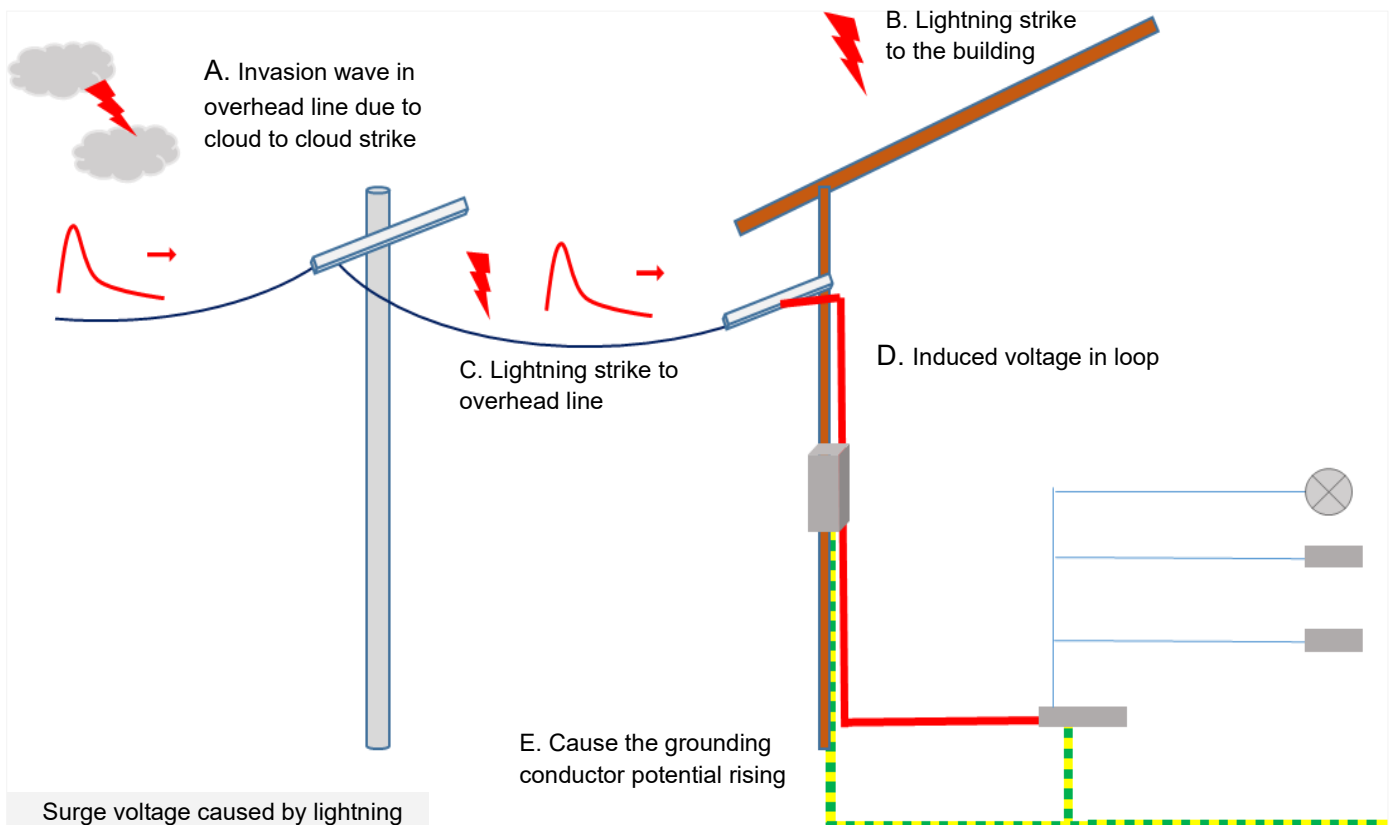

Surge voltage caused by lightning

SPD

Surge Protective Device

SD10KxxxD303(H100) Serie

Impulse Withstand Voltage and Surge Protection

As the primary equipment of internal lightning-proof, SPD needs to be able to withstand surge stress and provides the level of voltage protection required for the equipment. This involves the selection and coordination of SPD in different locations to form a complete protection system.

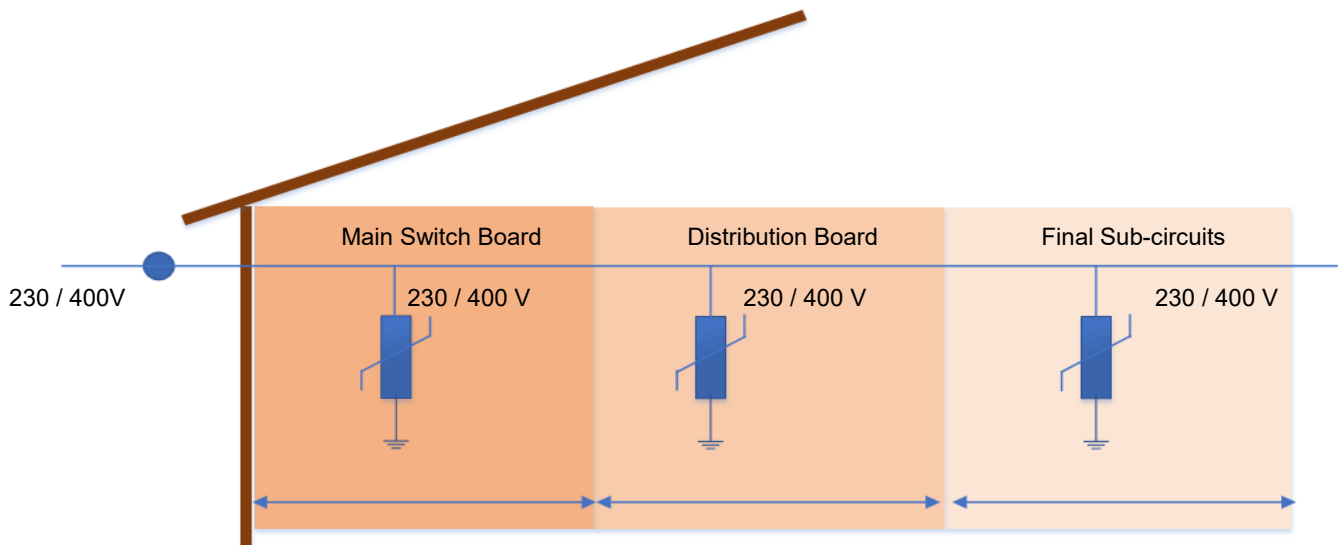
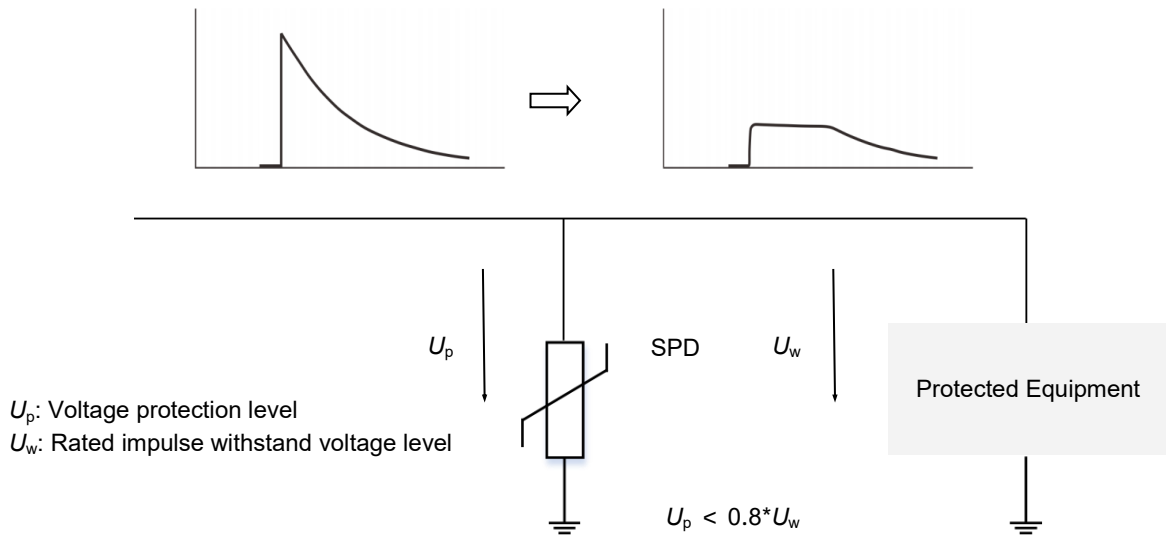

Overvoltage Category	IV	III	II	I
U_w (kV) Impulse Withstand Voltage	6	4	2.5	1.5
Lightning Protection Zone LPZ	LPZ1	LPZ2	LPZn	
SPD Type	Class I or Class II	Class II	Class II or Class III	

Glossary

Item	Description
U_p	<p>Voltage Protection Level Maximum voltage to be expected at the SPD terminals due to an impulse stress with defined voltage steepness and an impulse stress with a discharge current with given amplitude and waveshape. — (IEC 61643-11)</p>
8/20 μ s	<p>8/20 Current Impulse Current impulse with a nominal virtual front time of 8 μs and a nominal time to half-value of 20 μs. — (IEC 61643-11)</p>
1.2/50 μ s	<p>1.2/50 Voltage Impulse Voltage impulse with a nominal virtual front time of 1.2 μs and a nominal time to half-value of 50 μs. — (IEC 61643-11)</p>
U_c	<p>Maximum Continuous Operating Voltage Maximum r.m.s. voltage, which may be continuously applied to the SPD's mode of protection. — (IEC 61643-11)</p>
I_n	<p>Nominal Discharge Current Crest value of the current through the SPD having a current waveshape of 8/20. — (IEC 61643-11)</p>
I_{imp}	<p>Impulse Discharge Current for Class I Test Crest value of a discharge current through the SPD with specified charge transfer Q and specified energy W/R in the specified time. — (IEC 61643-11)</p>
I_{max}	<p>Maximum Discharge Current Crest value of a current through the SPD having an 8/20 waveshape and magnitude according to the manufacturers specification. I_{max} is equal to or greater than I_n. — (IEC 61643-11)</p>
Modes of Protection	<p>Modes of Protection An intended current path, between terminals that contains protective components, e.g. line-to-line, line-to-earth, line-to-neutral, neutral-to-earth. — (IEC 61643-11)</p>
IP	<p>Degrees of Protection Provided by Enclosure (IP Code) Classification preceded by the symbol IP indicating the extent of protection provided by an enclosure against access to hazardous parts, against ingress of solid foreign objects and possibly harmful ingress of water.</p>



ATTENTION

Usage

1. Frequency range is from 47 Hz to 63 Hz.
2. The voltage applied continuously to the SPD must not exceed its maximum continuous operating voltage U_c .
3. When atmosphere press is from 80 kPa to 106 kPa, the related altitude shall be from 2000 m to - 500 m.
4. Do not touch the product body or wires directly when power is on, to avoid electric shock.

Replacement

As SPD is a non-repairable product, for safety sake, please use the same type of SPD for replacement.

Storage

Do not store SPD at high temperature, high humidity or corrosive gas environment, to avoid oxidation of the wires. Use them up within 2 years after receiving the goods.

Installation

1. Installation and startup may only be carried out by qualified personnel. The relevant country-specific regulations must be observed.
2. Check the device for external damage before installation. If the device is defective, it must not be used.
3. Pay attention to risk of electric shock. Please cutoff all electrical power before installation or service.
4. Lay the output cables to the surge protective devices (SPDs) as short as possible, without loops.
5. Do not apply mechanical stress to the SPD body during or after the installation.

Maintenance

1. Check SPD status according to instructions before and after the thunderstorm season each year.
2. If the indicator of "failure state" appears, the SPD is damaged. Replace the SPD with same type.
3. Ensure electrical connections and mountings are correct before energizing the circuit.
4. SPD`s quality is well controlled and strictly inspected before delivery. If non-functional ones are found during operation, please contact us early enough.